

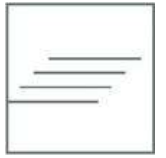

THE BEST AT HOME

GLASS GARDEN ROOMS



User manual / Assembly instructions

Side lock and Centre lock for

Fiano Sliding Glass Doors

Version: EN – November 2023

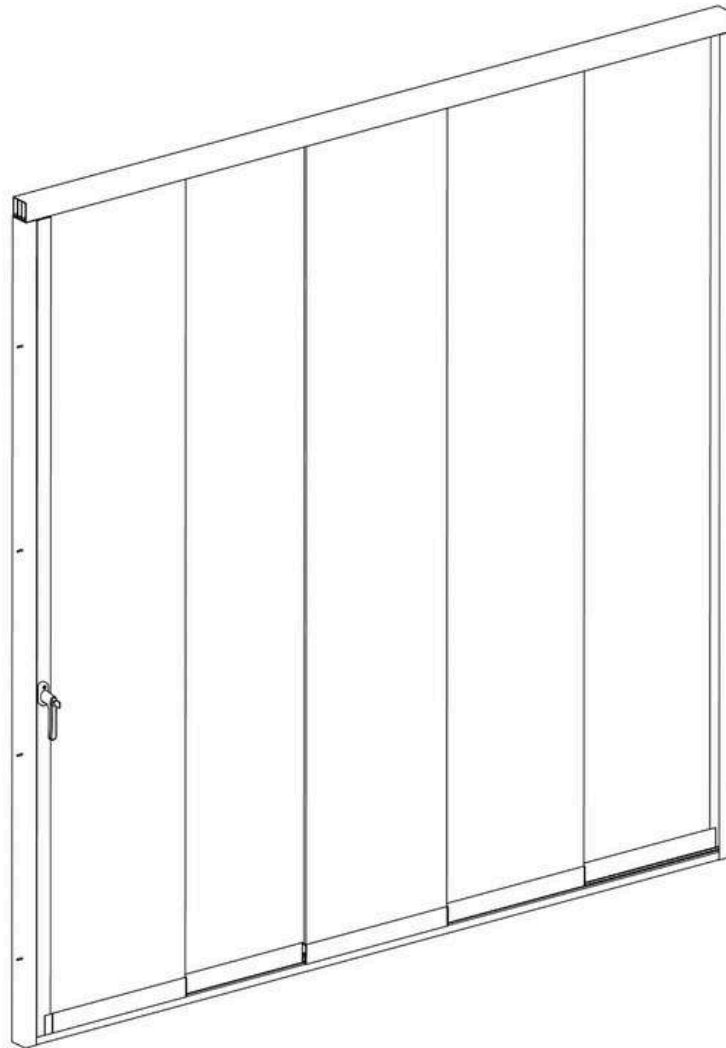

www.glassgardenroom.co.uk



1. Product description

The Fiano Sliding Glass Doors can be equipped with a closure in 2 variants:

- Side lock
- Centre lock

Both types of closure:

- Are equipped with a double sided operation handle and a one sided lock.
- Come with profiles suitable for permanently fixing the Fiano panel / panels located at the sides to the wall, facade or post.
- Are available in a standard length of 2500 mm and in 4 colours: Grey (RAL7024), Cream white (RAL9001), Traffic white (RAL9016) and Black (RAL9005).
- Are suitable for a Fiano system with a glass thickness of 10 mm.

Please take note!

To calculate the overlap of the Fiano panels, when using the side or centre lock, subtract 85mm from the measured width.

This manual is split into instructions for installing the Side lock and Centre lock versions.

For instructions on the Side lock, continue on **page 3**.

For instructions on the Centre lock, continue on **page 13**.



2. Parts overview Side lock

2.1 Exploded view

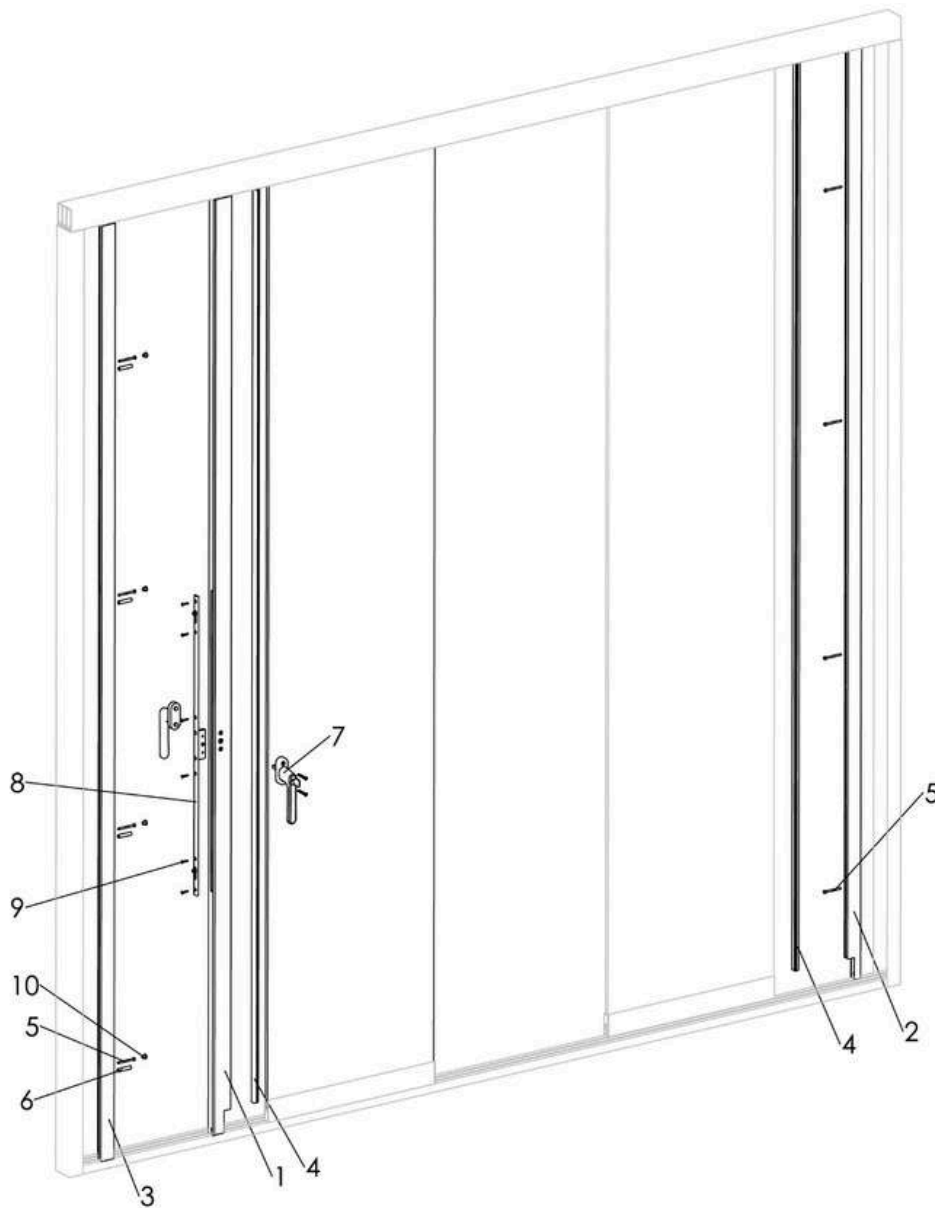

2.2 Delivery inspection

This manual shows a Fiano system, on which the Side lock will be mounted, with example dimensions. This example is only illustrative. This system is also equipped with trackers, which are recommended for optimum operation of the Side lock. These should be ordered separately.

Note: Always carefully check the delivered items against the accompanying delivery note to ensure that the quantity and quality are correct. Any visible defects must be reported in writing within 7 days of delivery.



2.3 Parts list

The following overview shows which parts are packed together. Carefully check the individual packaging units against the order form for quantity and quality.

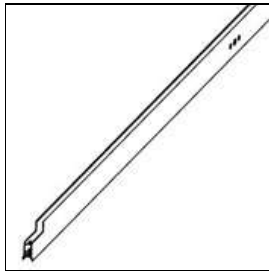

01. 1x Handle profile
2500mm

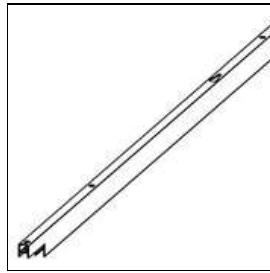

02. 1x Glass profile
2500mm

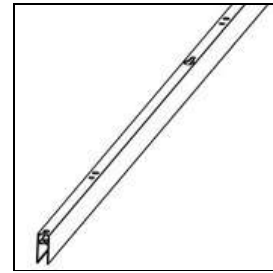

03. 1x Locking profile
2500mm

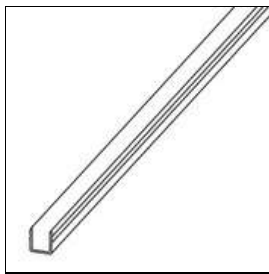

04. 2x U-rubber
2440mm

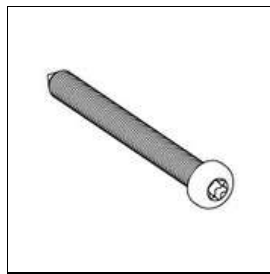

05. 8x Self-tapping
screw ST4,2x50 RVS

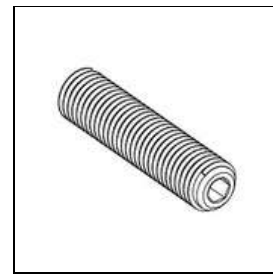

06. 4x Adjusting
screw M8x40 RVS

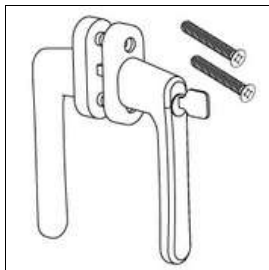

07. 1x Double sided
handle with lock
(including 2x screw
countersunk head
M5x35 RVS)

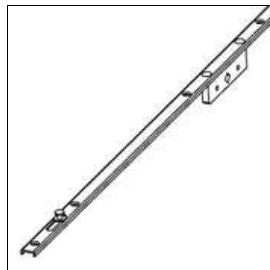

08. 1x Espagnolette

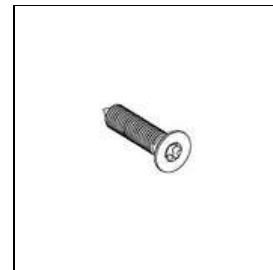

09. 6x Plate screw
countersunk head
ST3,5x19 RVS

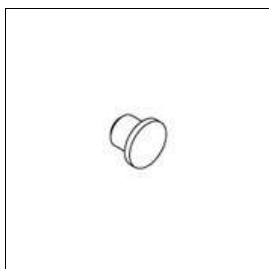

10. 4x Sealing cap



3. Preparation for assembly Side lock

3.1 Conditions for assembly

General

- Make sure the Fiano Sliding Glass Doors system is completely installed.



The aluminium profiles need to be shortened to the right size. Always short the profiles at the top, this is the side without cut-out.

Dimensions

- The Side lock is suitable for an installation height of maximum 2500 mm.

Screws and drilling

- Tempered glass can **NOT** be drilled, ground or cut.
- Pre-drill screw holes with a bit of around \varnothing 3 mm



Note: If you continue to turn the stainless steel screws after they are tight, the screw head may break off. It is recommended that you screw carefully, with the torque limiter on your drill set properly.

Remove protective film

- It is recommended that the protective film be removed from the aluminium parts at the last possible moment, to prevent damage.

Warranty is void if the Side lock is not assembled and installed in accordance with the instructions.

3.2 Measuring & determining dimensions glass panels

- Decide where the closure will be placed. The Side lock can be placed either on the panel on the far left or on the far right. It is preferred that this be the inner panel (the one in the front as seen from inside).
- For correct closure, adjust the panels on which the Side lock will be mounted parallel.



4. Assembly Side lock

4.1 Handle profile

The handle profile will be mounted onto the panel on the side, so that this panel, with help of the locking profile, can be locked into place.



1. Take the glass panel on which the Side lock will be mounted. Determine the distance between the underside of the H-profile of the glass panel in question and the underside of the top rail in three scenarios: when the panel is located on the left outer side, when the panel is slid to the right outer side and when the panel is positioned in the centre. It is needed to determine this distance over multiple positions due to possible differences in height. Take the smallest distance measured. This will be size H.

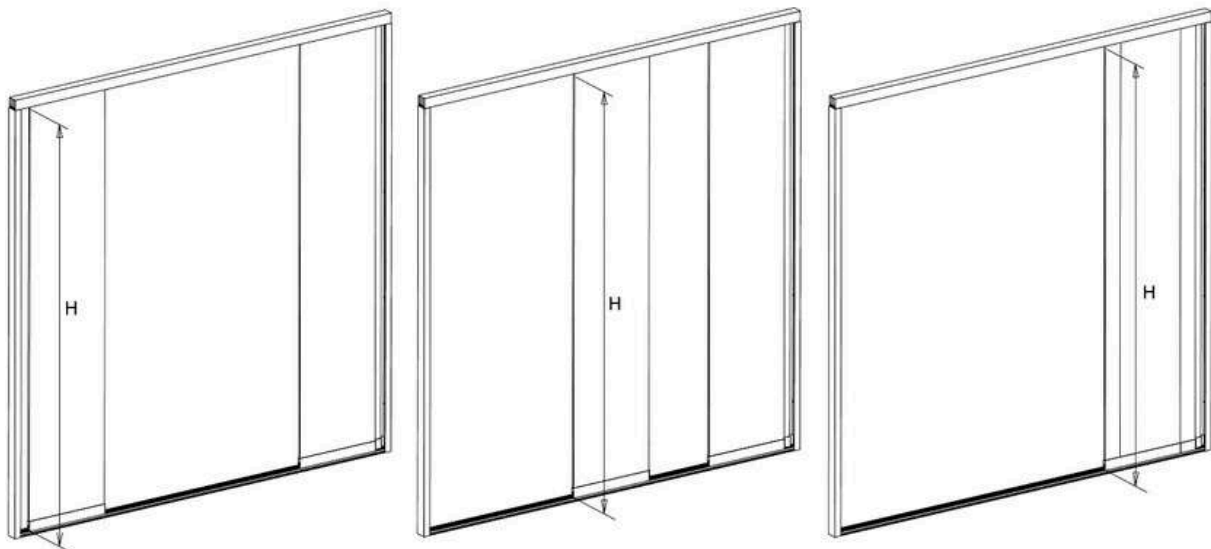



2. Shorten the handle profile to the correct length, this being size H minus 5 mm. The profile must be shortened on the top side, which is the side without the cut-out.

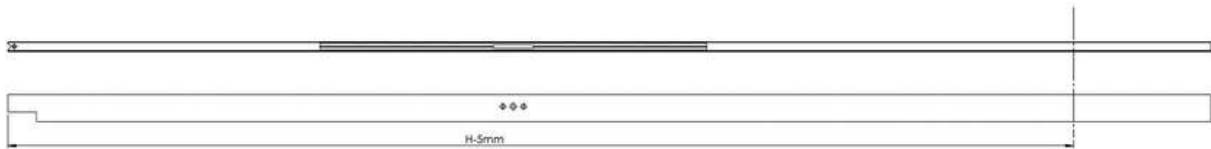

3. Remove the cover, including screw and rubber cap, from the H-profile of the glass panel on the side where the handle profile is to be placed. Keep the rubber caps, they will be used again later.

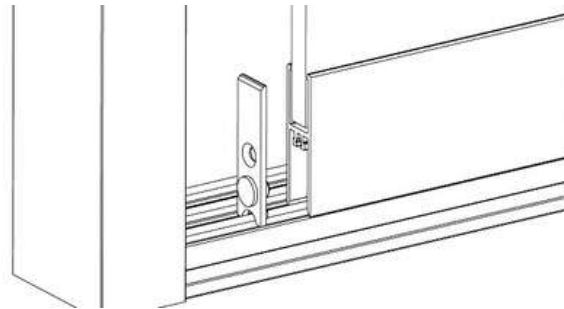

4. Cut the U-rubber to the correct length, this being size H minus 20 mm.

5. Place the U-rubber, on the same side of the panel, along the entire length of the glass.

6. Place the handle profile with its open side over the U-rubber, make sure it fits tightly. Tap it in with a rubber mallet, and put a wooden plank or block in between so that the protruding parts do not deform. Ensure that the cut-out on the underside of the handle profile fits seamlessly with the H-profile of the glass panel.

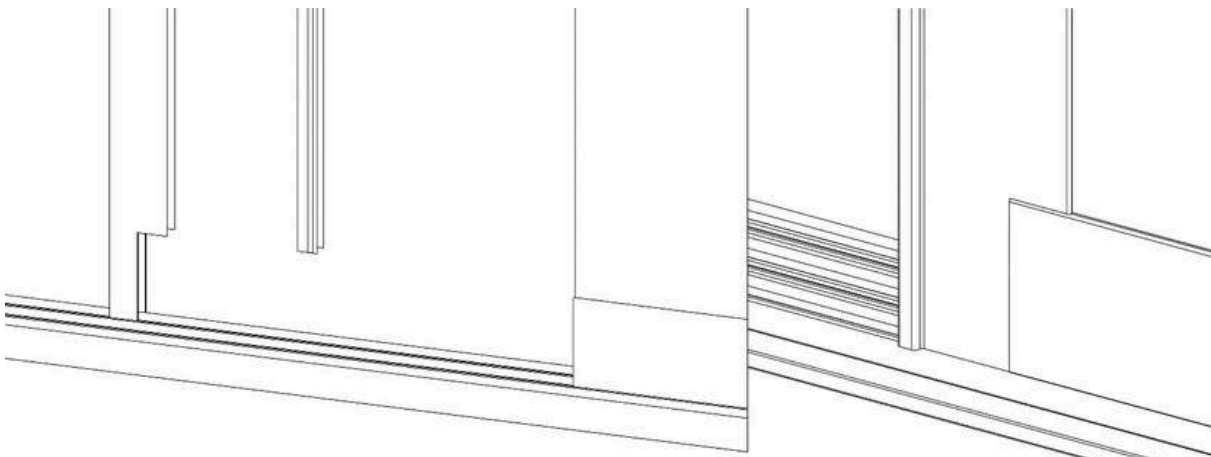



7. Proceed to press the espagnolette into the recess in the centre. Make sure it fits seamlessly and flush. If necessary, tap the espagnolette in with a mallet.

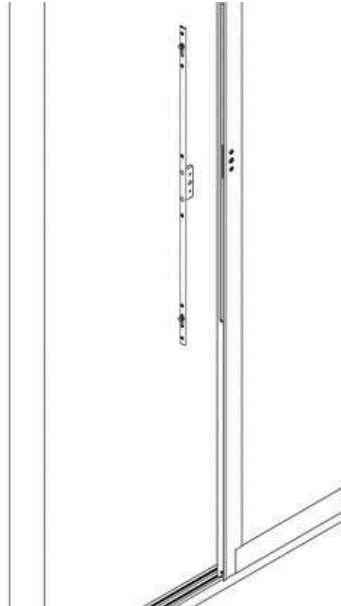

8. Place the handle into the espagnolette, with the square peg through the middle opening. Verify the position of the handle and the workings of the espagnolette. When the handle lever is vertically down, the locking cams of the espagnolette must be in the upper position (closed situation).

9. Drill through the threaded holes (indicated with arrows in the illustration) in the espagnolette with drill bit \varnothing 5.5.

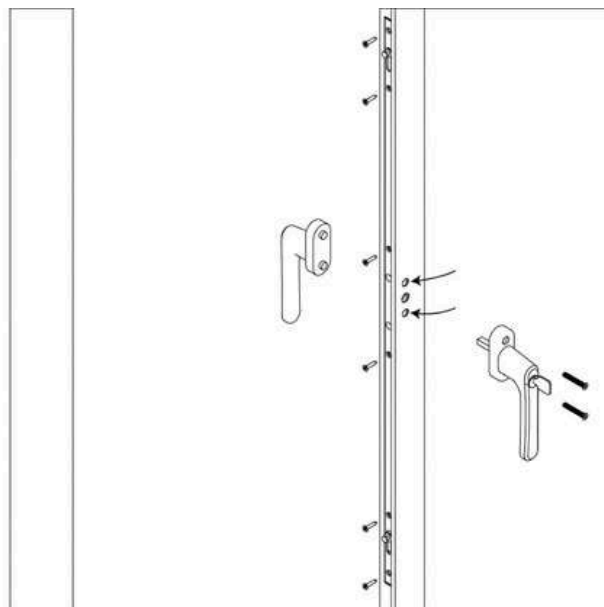

10. Screw down the espagnolette with screws ST3.5x19 (6x).

11. Mount the handle on the inside and outside, with the lock on the desired side, to the handle profile using the included stainless steel M5x35 screws.



4.2 Locking profile

Next, we are going to mount the locking profile to the wall, facade or post, so that the handle profile can hook onto it, and the glass wall can be closed off on this side.



1. Determine the distance between the underside of the H-profile and the underside of the top rail on the side where the closure is going to be mounted. This will be size L1.

2. Saw the locking profile to the correct length, this being size L1 minus 2 mm. The profile must be shortened at the top, which is the side without cut-out.



3. Insert the M8x40 adjusting screws into the locking profile. Insert these in the bottom hole of each of the 4 pairs of holes. Make sure they are flush with the surface of the locking profile.

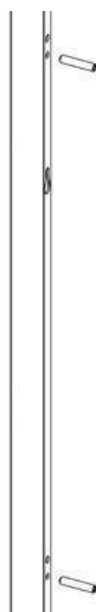
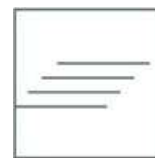

4. Place the locking profile with its underside in line with the underside of the handle profile on the wall, facade or post or on the previously installed U-profile (U-profile is optional when installing the Fiano sliding glass wall).

Attention! Ensure that the locking profile is placed in line with the handle profile and closure, so that the handle profile falls over the locking profile correctly.

5. Now hand-tighten the locking profile using the 4 self-tapping screw ST4,2x50. Insert the self-tapping screw in the top hole of each of the 4 pairs of holes.

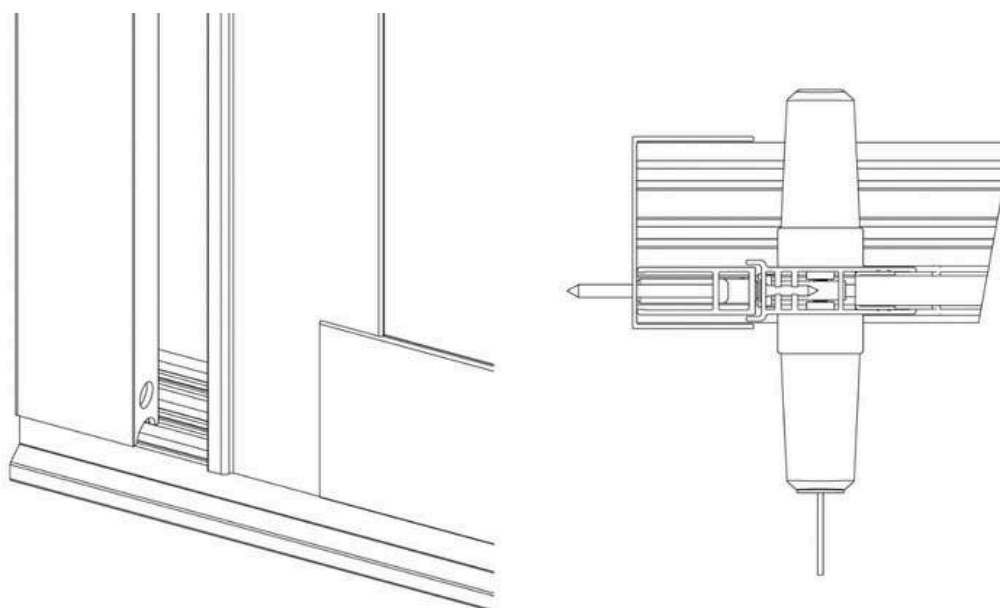

6. Adjust the locking profile parallel to the handle profile by unscrewing one or more of the adjusting screws previously inserted. To do this, the self-tapping screw that were just placed must be loosened slightly.

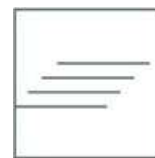

7. Screw the locking profile into place.

8. Insert the 4 sealing caps to cover the screw holes.

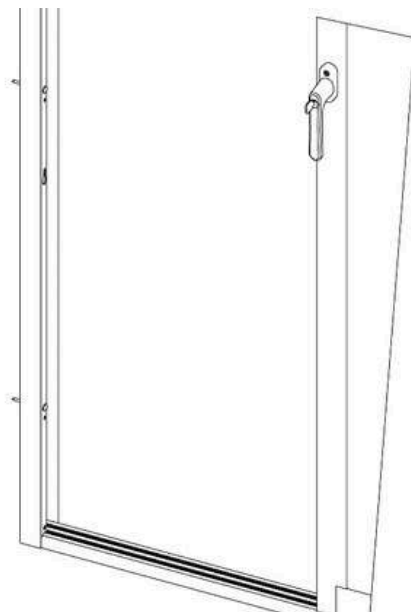

4.3 Glass profile wall mount

At the opposite side of the sliding glass wall the glass panel will be mounted to the wall, facade or post, so that the wall cannot be opened from this side. The glass profile will be used for this.



1. Determine the distance between the underside of the H-profile of the glass panel and the underside of the top rail at the wall. This will be size L2.

Please note! This size L2 may differ from the previously measured size L1.



2. Shorten the glass profile to the correct size, this being size L2 minus 2 mm. The profile must be shortened on the top side, which is the side without the cut-out.

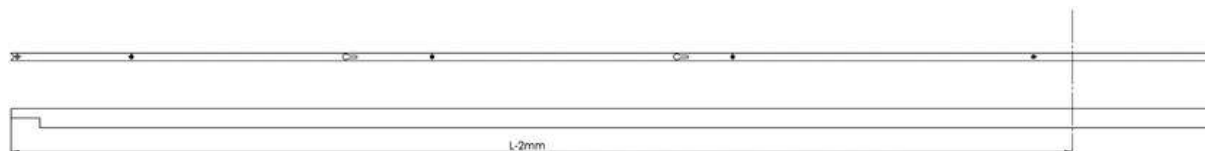

3. Remove the cover, including screw and rubber cap, from the H-profile on this side of the glass panel.

4. Place the glass profile, with its underside in line with the underside of the glass panel on the wall, facade or post or on the previously installed U-profile (U-profile is optional when installing the Fiano sliding glass wall).

Attention! Ensure that the locking profile is placed in line with the glass panel.

5. Now tighten the glass profile using the 4 self-tapping screw ST4,2x50.

6. Place the U-rubber along the entire length of the glass.

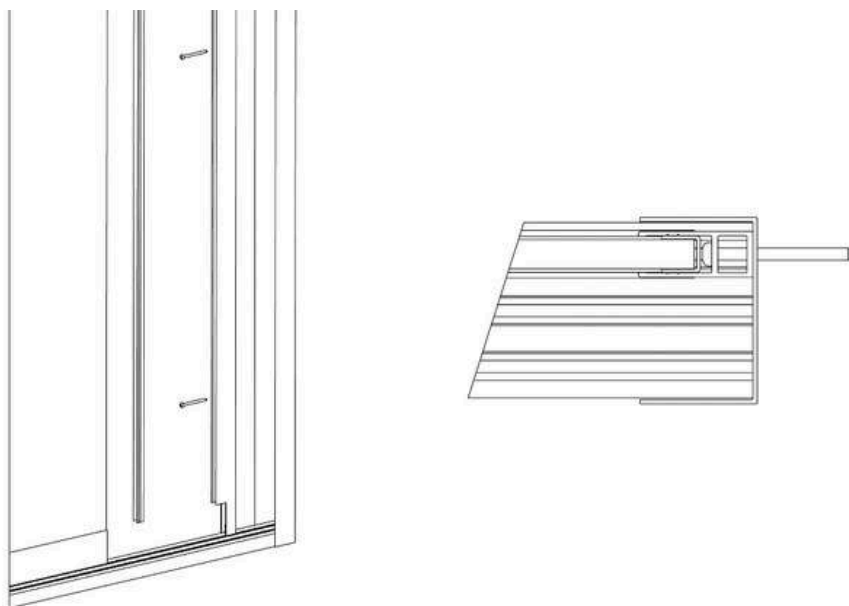

7. Press the glass panel with the U-rubber into the glass profile. Tap the glass panel in with a rubber mallet, and put a wooden plank or block in between, so that no gap is visible anymore between the glass profile and H-profile.

This concludes the assembly instructions for the Side lock. Continue reading on page 22.



5. Parts overview Centre lock

5.1 Exploded view



4.2 Delivery inspection

This manual shows a Fiano system, on which the Centre lock will be mounted, with example dimensions. This example is only illustrative. This system is also equipped with trackers, which are recommended for optimum operation of the Centre lock. These should be ordered separately.

Note: Always carefully check the delivered items against the accompanying delivery note to ensure that the quantity and quality are correct. Any visible defects must be reported in writing within 7 days of delivery.



4.3 Parts list

The following overview shows which parts are packed together. Carefully check the individual packaging units against the order form for quantity and quality.

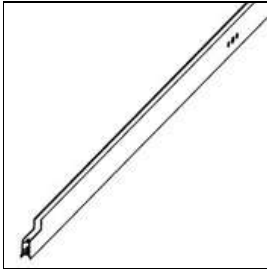

01. 1x Handle profile
2500mm

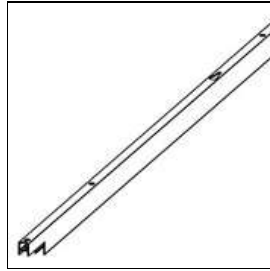

02. 3x Glass profile
2500mm

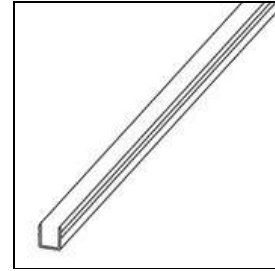

04. 4x U-rubber
2440mm

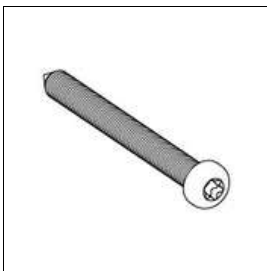

05. 8x Self-tapping
screw ST4,2x50 RVS

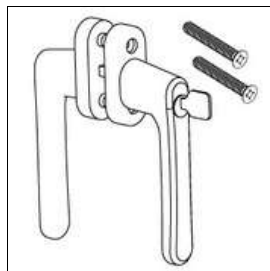

07. 1x Double sided
handle with lock
(including 2x screw
countersunk head
M5x35 RVS)

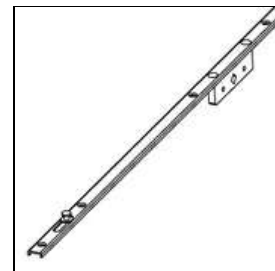

08. 1x Espagnolette

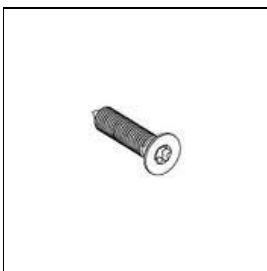

09. 6x Plate screw
countersunk head
ST3,5x19 RVS

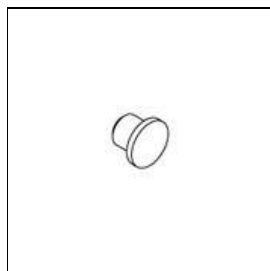

10. 4x Sealing cap



6. Preparation for assembly Centre lock

6.1 Conditions for assembly

General

- Make sure the Fiano Sliding Glass Doors system is completely installed.



The aluminium profiles need to be shortened to the right size. Always short the profiles at the top, this is the side without cut-out.

Dimensions

- The Centre lock is suitable for an installation height of maximum 2500 mm.

Screws and drilling

- Tempered glass can **NOT** be drilled, ground or cut.
- Pre-drill screw holes with a bit of around \varnothing 3 mm



Note: If you continue to turn the stainless steel screws after they are tight, the screw head may break off. It is recommended that you screw carefully, with the torque limiter on your drill set properly.

Remove protective film

- It is recommended that the protective film be removed from the aluminium parts at the last possible moment, to prevent damage.

Warranty is void if the Centre lock is not assembled and installed in accordance with the instructions.

6.2 Measuring & determining dimensions glass panels

- Decide where the closure will be placed. The Centre lock is meant to be placed in between two glass panels on the same rail, near or in the middle of the glass wall. It is preferred that these are the inner panels (the ones in the front as seen from the inside).
- For correct closure, adjust the panels on which the Centre lock will be mounted parallel.



7. Assembly Centre lock

7.1 Handle profile

The handle profile will be mounted onto a centre panel so that it, with help of the glass profile, can be locked into place.



1. Take the glass panel on which the Centre lock will be mounted. Determine the distance between the underside of the H-profile of the glass panel in question and the underside of the top rail in three scenarios: when the panel is located on the left outer side, when the panel is slid to the right outer side and when the panel is positioned in the centre. It is needed to determine this distance over multiple positions due to possible differences in height. Take the smallest distance measured. This will be size H.

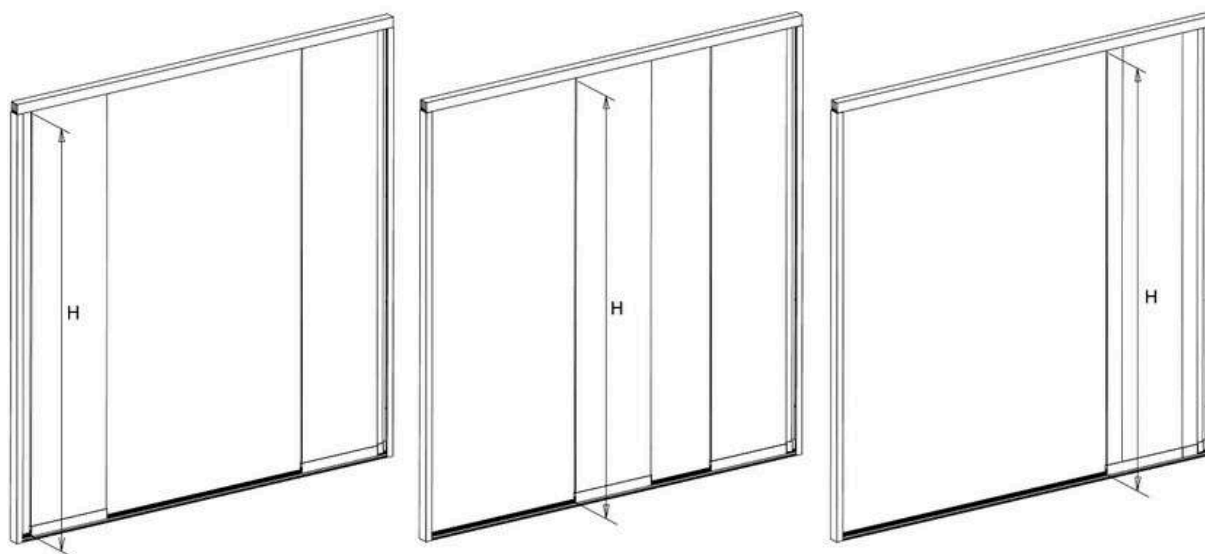



2. Shorten the handle profile to the correct length, this being size H minus 5 mm. The profile must be shortened on the top side, which is the side without the cut-out.

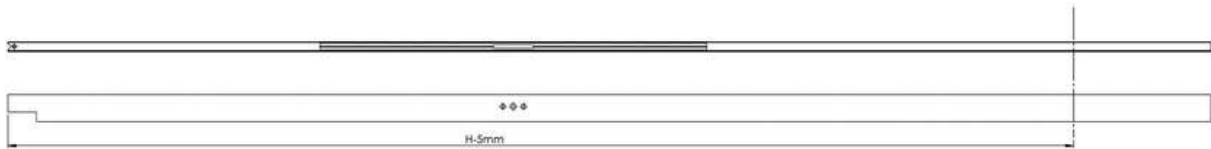

3. Remove the cover, including screw and rubber cap, from the H-profile of the glass panel on the side where the handle profile is to be placed. Keep the rubber caps, they will be used again later.

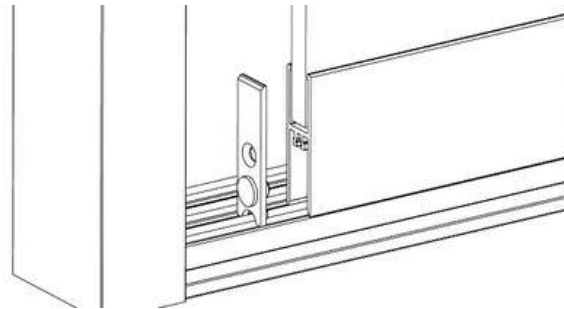

4. Cut the U-rubber to the correct length, this being size H minus 20 mm.

5. Place the U-rubber, on the same side of the panel, along the entire length of the glass.

6. Place the handle profile with its open side over the U-rubber, make sure it fits tightly. Tap it in with a rubber mallet, and put a wooden plank or block in between so that the protruding parts do not deform. Ensure that the cut-out on the underside of the handle profile fits seamlessly with the H-profile of the glass panel.

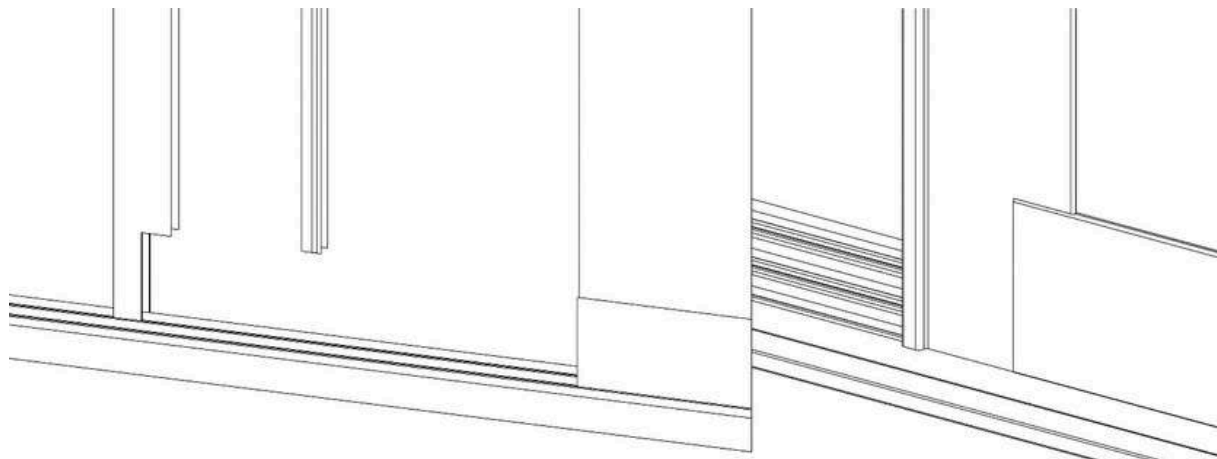

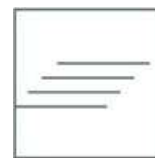

7. Proceed to press the espagnolette into the recess in the centre. Make sure it fits seamlessly and flush. If necessary, tap the espagnolette in with a mallet.

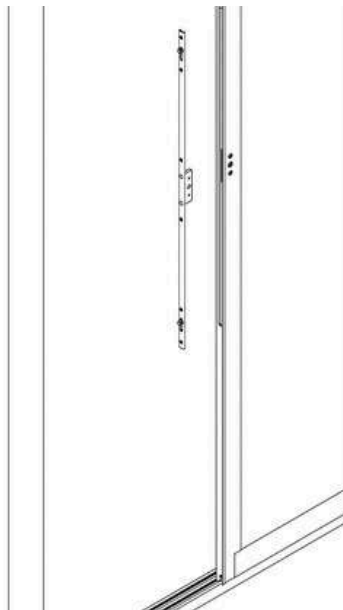

8. Place the handle into the espagnolette, with the square peg through the middle opening. Verify the position of the handle and the workings of the espagnolette. When the handle lever is vertically down, the locking cams of the espagnolette must be in the upper position (closed situation).

9. Drill through the threaded holes (indicated with arrows in the illustration) in the espagnolette with drill bit \varnothing 5.5.

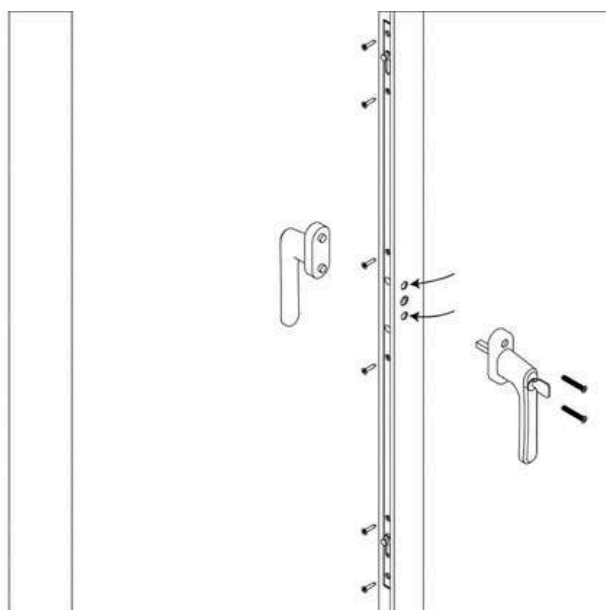

10. Screw down the espagnolette with screws ST3.5x19 (6x).

11. Mount the handle on the inside and outside, with the lock on the desired side, to the handle profile using the included stainless steel M5x35 screws.

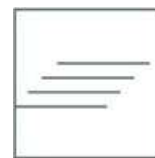

7.2 Glass profile

Next, mount one of the glass profiles to the glass panel next to it (on the same track), so that the handle profile can hook onto it and the glass wall can be closed.



1. The glass profile is going to be mounted to the adjacent glass panel, located on the same track. Saw the glass profile to the correct length, this being size H minus 5 mm. The profile must be shortened at the top, which is the side without the cut-out.

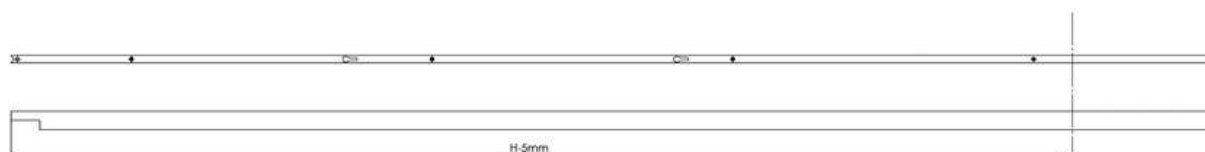

2. Remove the cover, including screw and rubber cap, from the H-profile of the glass panel on the side where the glass profile is to be placed.

3. Cut the U-rubber to the correct length, this being size H minus 20 mm.

4. Place the U-rubber, on the same side of the panel, along the entire length of the glass.

5. Place the glass profile with its open side over the U-rubber, make sure it fits tightly. Tap it in with a rubber mallet, and put a wooden plank or block in between so that the protruding parts do not deform. Ensure that the cut-out on the underside of the glass profile fits seamlessly with the H-profile of the glass panel.

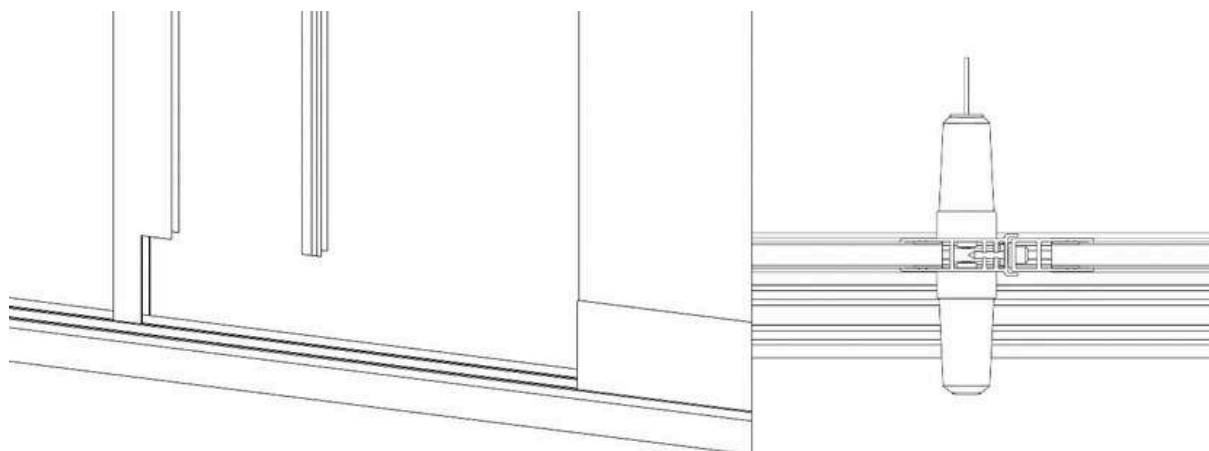

6. Insert the 4 sealing caps to cover the screw holes.

7.3 Glass profile wall mount

On both ends of the sliding glass wall system the glass panels are going to be mounted to the wall, facade or post, so that the wall cannot be opened from these sides. The other two glass profiles will be used for this.



1. Determine the distance between the underside of the H-profile of the glass panel and the underside of the top rail at the wall. This will be size L2.

Please note! This size L2 may differ from the previously measured size L1.

2. Shorten the glass profile to the correct size, this being size L2 minus 2 mm. The profile must be shortened on the top side, which is the side without the cut-out.

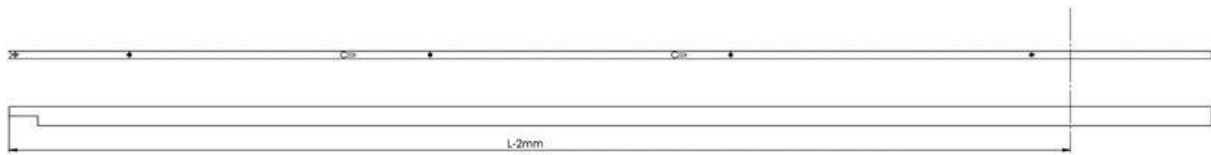

3. Remove the cover, including screw and rubber cap, from the H-profile on this side of the glass Panel.

4. Place the glass profile, with its underside in line with the underside of the glass panel on the wall, facade or post or on the previously installed U-profile (U-profile is optional when installing the Fiano sliding glass wall).

Attention! Ensure that the locking profile is placed in line with the glass panel

5. Now tighten the glass profile using the 4 self-tapping screw ST4,2x50.

6. Place the U-rubber along the entire length of the glass.

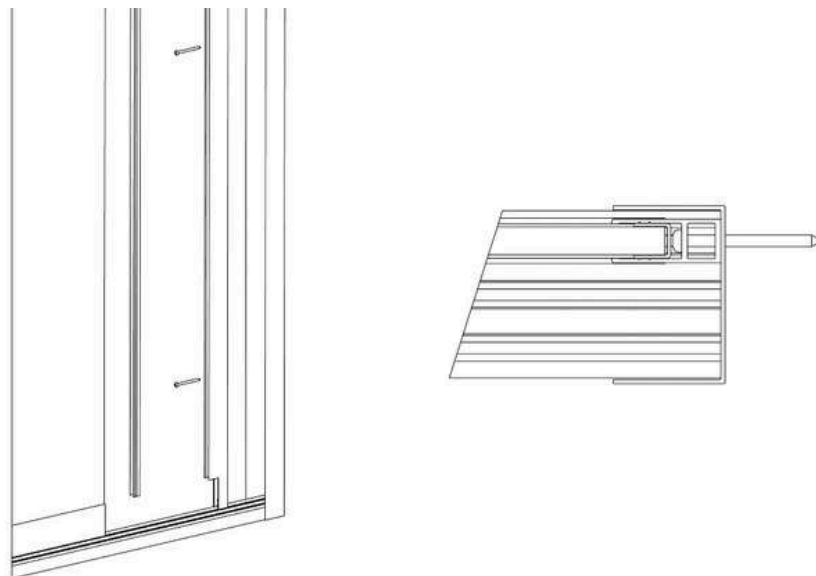

7. Press the glass panel with the U-rubber into the glass profile. Tap the glass panel in with a rubber mallet, and put a wooden plank or block in between, so that no gap is visible anymore between the glass profile and H-profile.

8. Repeat these instructions for the glass panel on the other side of the sliding glass wall. Make sure to measure size L2 again.

This concludes the assembly instructions for the Centre lock.



8. Warranty conditions

Warranty in accordance with the warranty conditions and Deponti's general terms and conditions. These can be found on the website www.deponti.com.

The powder coating has a 5-year warranty. Please note, the powder coating warranty of aluminium parts is two years when the product is placed in a place where it comes into contact with salty or chemical steam (such as harbours, coast and swimming pools).